

CONFIGURATION

Overhead Guard	Combination Instrument
Top Rain Shelter	Working Hour Meter
Pedal Rubber	Oil Content Meter
Semi-suspension Seat	Water-thermometer
Automatic Shift	Charging Indicator
Electro-hydraulic Reversing	Neutral Position Switch
Wide Field Mast (2 Stage)	Oil Pressure Warning
Backrest	Electric Horn
Standard Forks	LED Signal Lamp
Adjustable Steering Column	Reversing Buzzer
Lifting and Tilting Joysticks	Key Shutoff Device
Two Piece Multiplex Valve	Push-button Parking brake
Full-hydraulic Power Steering	Torque Converter Oil Gauge
Tilting Cylinder Latching Valve	Traction Pin
Transmission Oil Filter	Tool Box

OPTIONAL

Solid Tires	Driving OPS
Cabin	Full Set OPS (Including drive and lift)
Working Warning Light	Torque Converter Oil Temperature Alarm
Suspension Seat	Full Set LED Lamps
Warm-air Blower	Reversing Voice Horn
Front Windscreen	Overspeed alarm, 10km/h
Rear Working Lamp	Electric Fan
High Level Exhaust	Sound-light Alarm
Double Air Filter	Power Master Switch
Oil Bath Air Filter	Lengthen Fork Jacket
Fire Extinguishing Muffler	Tilting Cylinder Sleeve
Widen Fork Frame	Steering Cylinder Sleeve
Multiple Work Attachments	Custom Colors

PRODUCT FEATURES

<p>Good Heat Dissipation Cooling system is reasonable optimized, which improves cooling performance significantly. Thus improving reliability and durability of key components such as gearbox and engine.</p>
<p>Lowering Energy Consumption Optimized design of load sensing hydraulic system reduces vehicle fuel consumption effectively.</p>
<p>Operating Comfort Adopted interactive ergonomic design to improve operating comfort. Equipped with wide field of view mast to improve driver's field of view.</p>
<p>Intelligent Reversing Electro-hydraulic Reversing System. Easy to operate and labor-saving. Upgrade new intelligent shift system, prevent the second gear starting, ensure reliability of gearbox.</p>
<p>Convenient Maintenance Interior space of car body is more spacious. Parts Positions are more reasonable. Opening angle of hood is increased to 80°. Maintainability of machine is better.</p>
<p>High Reliability Strength of the core structural parts of car body, mast and hood has been enhanced greatly to make whole vehicle more solid.</p>

The following blank can be used for notes or comments.

**For more information on Lonking products,
Please contact our local agent:**

Lonking, Lonking LG Series and their respective logos, as well as corporate identity in this leaflet are trademarks of Lonking Holdings Ltd., and may not be used without written permission.
2020/04

Specifications and design are subject to change without prior notice.
Machines shown may not include optional accessories.

LONGKING 龙工

LG40/45/50DTIV

BALANCEWEIGHT TYPE FORKLIFT TRUCK WITH ENGINE

Efficiency Rules the Future



LONGKING (FU JIAN) INTERNATIONAL TRADE CO., LTD.

LONGKING HOLDINGS LIMITED

Add: 26 Minyi Road, Xinqiao, Songjiang Industrial Zone, Shanghai

Tel: +86-21-3760 2242 E-mail: export@lonking.cn

<http://www.lonkinggroup.com>

	LG40DTIV	LG45DTIV	LG50DTIV
Rated Capacity (kg)	4000	4500	5000
Load Center (mm)	500	500	500
Power Type	Diesel	Diesel	Diesel

OVERALL SPECIFICATIONS

Type	No.	Item	Code	Unit	Data		
Identification	1.01	Manufacturer			LONKING		
	1.02	Model			LG40DT IV	LG45DT IV	LG50DT IV
	1.03	Power type			Diesel		
	1.04	Rated capacity	Q	kg	4000	4500	5000
	1.05	Load center	J	mm	500	500	500
Dimensions	2.01	STD Max height (with backrest)		mm	4708	4708	4708
	2.02	STD Max lifting height	h1	mm	3000	3000	3000
	2.03	Overhead guard height	h4	mm	2250	2250	2250
	2.04	Overall length (with fork)	L1	mm	4245	4265	4310
	2.05	Wheelbase	L2	mm	2100	2100	2100
	2.06	Front overhang	L3	mm	555	555	555
	2.07	Rear overhang	L4	mm	540	540	585
	2.08	Min.ground clearance (Frame/Mast)	m1/m2	mm	175/170	175/170	175/170
	2.09	Overall width	W1	mm	1480	1480	1480
	2.10	Adjusting range of fork (outside)		mm	300-1340	300-1340	300-1340
	2.11	STD Fork size (L5*W*T)		mm	1070×150×55		
	2.12	Front wheel tread	S	mm	1180	1180	1180
	2.13	Rear wheel tread	P	mm	1190	1190	1190
	2.14	Min.turning radius	R1	mm	2830	2860	2900
	2.15	Min aisle width for pallet 1000×1200,crossways		mm	4655	4685	4725
	2.16	Min aisle width for pallet 800×1200,lengthways		mm	4785	4815	4855
Tires	3.01	Wheels number, front/rear (X=driven wheels)			X=2/2		
	3.02	Tires type			Pneumatic		
	3.03	Tires size, front			8.25-15-14PR	300-15-20PR	
	3.04	Tires size, rear			7.00-12-12PR		
Other Details	4.01	Max.traveling speed, loaded/unloaded		km/h	24/25	24/25	24/25
	4.02	Max.lifting speed, loaded/unloaded		mm/s	460/500	460/500	460/500
	4.03	Lowering speed, loaded/unloaded		mm/s	Loaded ≤ 600/Unloaded ≥ 300		
	4.04	Max.traction, loaded		KN	30	30	30
	4.05	Max.gradient, loaded/unloaded		%	20/20	20/20	20/20
	4.06	STD operating weight (with oil & water)		kg	6530	6760	7100
	4.07	Axles loading,front/rear (loaded)		kg	9430/1100	10180/1080	10850/1250
	4.08	Axles loading,front/rear (unloaded)		kg	2930/3600	2980/3780	3050/4050
	4.09	Service brake			Power brake-pedal		
	4.10	Parking brake			Mechanical-hand brake lever		
4.11	Drive type			Automatic			
4.12	Number of gear (front/rear)			2/1			
4.13	Fuel tank capacity		L	90			
4.14	Battery votage/capacity		V/Ah	2×12/90			

ENGINE OPTIONAL

Engine Model	Emission	Manufacturer	Rated Power	Max.Torque (N.m/rpm)	Bore/Cylinders Number/Displacement	Fuel Consumption
4DX23-82GG3U	CHN III	XICHA	60kW/2200rpm	320/1400-1700	102mm/4/3.857L	230g/kW.h
S6S-229	Euro III A	MITSUBISHI	52kW/2300rpm	248/1700	94mm/6/4.996L	260g/kW.h

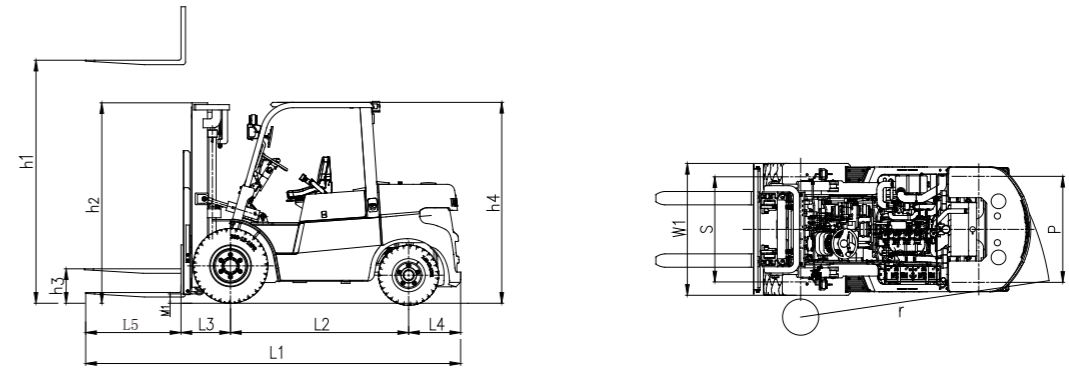

MAST SPECIFICATIONS

2 Stage Standard Mast-Super Wide Field

Mast Model	h1 Max Lifting Height(mm)	Load Capacity (J=500mm)(kg)			h2 Lowered Mast Height (mm)	h3 Free Lifting Height, without backrest (mm)	Mast tilt α/β (°)
		LG40DTIV	LG45DTIV	LG50DTIV			
M230	2300	4000	4500	5000	1895	155	6/12
M250	2500	4000	4500	5000	1995	155	6/12
M275	2750	4000	4500	5000	2120	155	6/12
M300	3000	4000	4500	5000	2245	155	6/12
M330	3300	4000	4500	5000	2395	155	6/12
M350	3500	4000	4500	5000	2495	155	6/12
M375	3750	4000	4500	5000	2620	155	6/12
M400	4000	4000	4500	5000	2795	155	6/6
M425	4250	3800*4000	4300*4500	4700*5000	2920	155	6/6
M450	4500	3700*4000	4200*4500	4500*5000	3045	155	6/6
M475	4750	3500*3700	4000*4200	4250*4600	3170	155	6/6
M500	5000	3200*3400	3600*4000	4000*4200	3295	155	6/6
M550	5500	*3200	*3600	*3800	3545	155	3/6
M600	6000	*2900	*3200	*3600	3795	155	3/6

Note: "*" means capacity of double front wheels.

2 Stage Free Mast-Super Free Lifting Height

Mast Model	h1 Max Lifting Height(mm)	Load Capacity (J=500mm)(kg)			h2 Lowered Mast Height (mm)	h3 Free Lifting Height, without backrest (mm)	Mast tilt α/β (°)
		LG40DTIV	LG45DTIV	LG50DTIV			
ZM200	2000	4000	4500	5000	1745	913	6/12
ZM250	2500	4000	4500	5000	1995	1163	6/12
ZM270	2700	4000	4500	5000	2095	1263	6/12
ZM300	3000	4000	4500	5000	2245	1413	6/12
ZM330	3300	4000	4500	5000	2395	1563	6/12
ZM350	3500	4000	4500	5000	2495	1663	6/12
ZM370	3700	4000	4500	5000	2620	1788	6/12
ZM400	4000	3800*3900	4300*4400	4800*4900	2745	1949	6/6

Note: "*" means capacity of double front wheels.With backrest, free lifting height reduces 189mm.

3 Stage Free Mast-Super Free Lifting Height

Mast Model	h1 Max Lifting Height(mm)	Load Capacity (J=500mm)(kg)			h2 Lowered Mast Height (mm)	h3 Free Lifting Height, without backrest (mm)	Mast tilt α/β (°)
		LG40DTIV	LG45DTIV	LG50DTIV			
ZSM320	3200	4000	4500	5000	1810	1028	6/6
ZSM360	3600	3900*4000	4400*4500	4900*5000	1944	1162	6/6
ZSM400	4000	3750*4000	4300*4500	4750*5000	2078	1296	6/6
ZSM435	4350	3500*3800	4100*4300	4400*4800	2194	1412	6/6
ZSM450	4500	3350*3500	4000*4200	4300*4600	2245	1463	6/6
ZSM480	4800	3150*3300	3700*3900	3950*4100	2345	1563	6/6
ZSM500	5000	3050*3200	3400*3700	3800*4000	2444	1662	6/6
ZSM540	5400	2750*3000	3000*3400	3500*3600	2569	1787	3/6
ZSM600	6000	1900*2500	2400*3000	2800*3400	2810	2028	3/6
ZSM650	6500	1200*1800	1800*2400	2300*2900	2977	2195	3/3

Note: "*" means capacity of double front wheels.With backrest, free lifting height reduces 189mm.