

## CONFIGURATION

Multi-function Instrument	High Efficiency AC Drive Motor
Lifting/Steering Computer Controlled	Gear Pump with Low Noise
Pedal Rubber	Load Sensing Hydraulic System
Lithium Battery	Top Rain Shelter
Emergency Power Off	Electric Horn
Reversing Buzzer	Wide-angle Rearview Mirror
Standard Seat	Traction Pin
Full-hydraulic Power Steering	Tool Box
Wide Field Mast	Standard Forks
Solid Tires	Lifting and Tilting Joysticks
Two Piece Multiplex Valve	

## OPTIONAL

Cabin	Widen and Lengthen Backrest
Cold A/C	Widen Fork Frame
Warm-air Blower	Electric Fan
Suspension Seat	Reversing Handrail Horn
Lifting Potentiometer	Corner Positioner
Battery Charger	Lengthen Fork Jacket
Rotate Buzzer Beacon	Tilting Cylinder Sleeve
Rear Working Lamp	Steering Cylinder Sleeve
Working Warning Light	Custom Colors
Green Solid Tires	Multiple Work Attachments
Protective Net	

## PRODUCT FEATURES

<p><b>Attractive Appearance</b> Vehicle appearance is designed by professional industrial design methods. Artistic and Strengthful.</p>
<p><b>Strong Stability</b> Battery is sinking designed to ensure vehicle stability. Integral type axle &amp; gear box and short front overhang improve vehicle longitudinal stability. Rear axle improves vehicle lateral stability.</p>
<p><b>Operating Comfort</b> Short diameter steering wheel and right-hand joysticks reduce operator's arm fatigue. Sinking designed tilting cylinders increase operator's foot space and safety. Spines tooth type hand brake conforms the motion of arm. Comfortable control.</p>
<p><b>Energy Efficiency</b> Transmission system and electric motor are professional matching designed. Battery life is prolonged by 30 minutes. Automatic turning slowdown function is optional. Equipped with LED light, energy and efficient.</p>
<p><b>Well-adapted</b> Adapt to different working environment.</p>
<p><b>Convenient Maintenance</b> Special locking structure and side panel structure designed makes battery maintenance very convenient.</p>

The following blank can be used for notes or comments.

**For more information on Lonking products,  
Please contact our local agent:**

Lonking, Lonking LG Series and their respective logos, as well as corporate identity in this leaflet are trademarks of Lonking Holdings Ltd., and may not be used without written permission.  
2020/06

Specifications and design are subject to change without prior notice.  
Machines shown may not include optional accessories.

# LONKING 龙工

## LG40/50B

**BALANCEWEIGHT TYPE FORKLIFT TRUCK WITH BATTERY**  
**Efficiency Rules the Future**



LONKING (FU JIAN) INTERNATIONAL TRADE CO., LTD.

**LONKING HOLDINGS LIMITED**

Add: 26 Minyi Road, Xinqiao, Songjiang Industrial Zone, Shanghai

Tel: +86-21-3760 2242 E-mail: export@lonking.cn

<http://www.lonkinggroup.com>

	LG40B	LG50B
Rated Capacity (kg)	4000	5000
Load Center (mm)	500	500
Power Type	Electric (AC)	Electric (AC)

## OVERALL SPECIFICATIONS

Type	No.	Item	Code	Unit	Data	
Identification	1.01	Manufacturer			LONKING	
	1.02	Model			LG40B	LG50B
	1.03	Power type			Electric (AC)	
	1.04	Rated capacity	Q	kg	4000	5000
	1.05	Load center	J	mm	500	500
Dimensions	2.01	STD Max height (with backrest)		mm	4066	4066
	2.02	STD Max lifting height	h1	mm	3000	3000
	2.03	Overhead guard height	h4	mm	2353	2353
	2.04	Overall length (with fork)	L1	mm	4025	4075
	2.05	Wheelbase	L2	mm	2000	2000
	2.06	Front overhang	L3	mm	545	545
	2.07	Rear overhang	L4	mm	410	460
	2.08	Min.ground clearance (Frame/Mast)	m1/m2	mm	150/175	150/175
	2.09	Overall width	W1	mm	1479	1479
	2.10	Adjusting range of fork (outside)		mm	300-1380	305-1335
	2.11	STD Fork size (L5*W*T)		mm	1070×150×55	
	2.12	Front wheel tread	S	mm	1228	1228
	2.13	Rear wheel tread	P	mm	1030	1030
	2.14	Min.turning radius	R1	mm	2685	2730
	2.15	Min aisle width for pallet 1000×1200,crossways		mm	4500	4545
	2.16	Min aisle width for pallet 800×1200,lengthways		mm	4630	4675
Tires	3.01	Wheels number, front/rear (X=driven wheels)			X=2/2	
	3.02	Tires type			Solid Tires	
	3.03	Tires size, front			250-15/7.5	
	3.04	Tires size, rear			21×8-9	
Other Details	4.01	Max.traveling speed, loaded/unloaded		km/h	14/14.5	
	4.02	Max.lifting speed, loaded/unloaded		mm/s	250/400	250/400
	4.03	Lowering speed, loaded/unloaded		mm/s	Loaded≤600/Unloaded≥300	
	4.04	Max.gradient, loaded		%	15	15
	4.05	STD operating weight (with oil & water)		kg	6060	6690
	4.06	Axles loading,front/rear (loaded)		kg	9112/948	10630/1135
	4.07	Axles loading,front/rear (unloaded)		kg	3016/3044	2945/3745
	4.08	Drive motor		kw	18	18
	4.09	Lift motor		kw	25.4	25.4
	4.10	Controller			inmotion	inmotion
	4.11	Li-ion Battery votage/capacity		V/Ah	80/400	

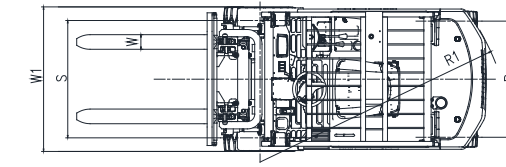
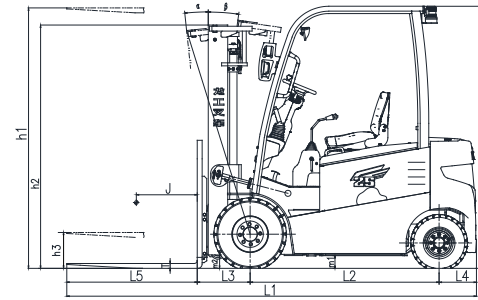

## MAST SPECIFICATIONS

### 2 Stage Standard Mast-Super Wide Field

Mast Model	h1 Max Lifting Height(mm)	Load Capacity (J=500mm) (kg)		h2 Lowered Mast Height (mm)	h3 Free Lifting Height, without backrest (mm)	Mast tilt α/β (°)
		LG40B	LG50B			
M230	2300	4500	5000	1895	155	6/10
M250	2500	4500	5000	1995	155	6/10
M275	2750	4500	5000	2120	155	6/10
M300	3000	4500	5000	2245	155	6/10
M330	3300	4500	5000	2395	155	6/10
M350	3500	4500	5000	2495	155	6/10
M375	3750	4500	5000	2620	155	6/10
M400	4000	4300	4800	2795	155	6/6
M425	4250	4050	4500	2920	155	6/6
M450	4500	3800	4200	3045	155	6/6
M475	4750	3500	3900	3170	155	6/6
M500	5000	3200	3600	3295	155	6/6
M550	5500	2600	2950	3545	155	3/6
M600	6000	2100	2100	3795	155	3/6

### 2 Stage Free Mast-Super Free Lifting Height

Mast Model	h1 Max Lifting Height(mm)	Load Capacity (J=500mm) (kg)		h2 Lowered Mast Height (mm)	h3 Free Lifting Height, without backrest (mm)	Mast tilt α/β (°)
		LG40B	LG50B			
ZM200	2000	4000	5000	1745	913	6/10
ZM250	2500	4000	5000	1995	1163	6/10
ZM270	2700	4000	5000	2095	1263	6/10
<b>ZM300</b>	<b>3000</b>	<b>4000</b>	<b>5000</b>	<b>2245</b>	<b>1413</b>	<b>6/10</b>
ZM330	3300	4000	5000	2395	1563	6/10
ZM350	3500	3960	4950	2495	1663	6/10
ZM375	3750	3840	4800	2620	1788	6/10
ZM400	4000	3720	4650	2745	1949	6/6

Note: Free lifting height reduces 189mm with backrest.

### 3 Stage Free Mast-Super Free Lifting Height

Mast Model	h1 Max Lifting Height(mm)	Load Capacity (J=500mm) (kg)		h2 Lowered Mast Height (mm)	h3 Free Lifting Height, without backrest (mm)	Mast tilt α/β (°)
		LG40B	LG50B			
ZSM320	3200	4000	5000	1810	1028	6/6
ZSM360	3600	3960	4950	1944	1162	6/6
ZSM400	4000	3760	4700	2078	1296	6/6
ZSM435	4350	3320	4150	2194	1412	6/6
<b>ZSM450</b>	<b>4500</b>	<b>3200</b>	<b>4000</b>	<b>2245</b>	<b>1463</b>	<b>6/6</b>
ZSM480	4800	3000	3750	2345	1563	6/6
ZSM500	5000	2800	3500	2444	1662	6/6
ZSM540	5400	2360	2950	2569	1787	3/6
ZSM600	6000	1760	2200	2810	2028	3/6
ZSM650	6500	1240	1550	2977	2195	3/3

Note: Free lifting height reduces 239mm with backrest.